

WHIRL-PAK®

results you can trust



STERILIZED SAMPLE COLLECTION AND PROCESSING BAGS

Ideal for:

biomedical • dairy • environmental • food & beverage • forensic science • genetics
industrial markets • medical • pharmaceutical • research • soil • surface • veterinary • water

2019
Product Guide

Nasco SAMPLING
brand



Whirl-Pak® is proud to celebrate 60 years as a trusted partner to our customers around the world by providing quality, dependable, sterilized sample and collection products.

Thank you for partnering with us as we continue our commitment to innovation by providing best-in-class features like post-manufacturing sterilization and puncture-proof closure tabs.

Because of you, our valued customers, Whirl-Pak® has become recognized as the *Gold Standard* in a world with critical and demanding sample integrity requirements.

At Whirl-Pak®, we believe in never sacrificing standards, whether in premium product quality, dedicated customer service, or our best-in-class guarantee.



WHIRL-PAK®
results you can trust

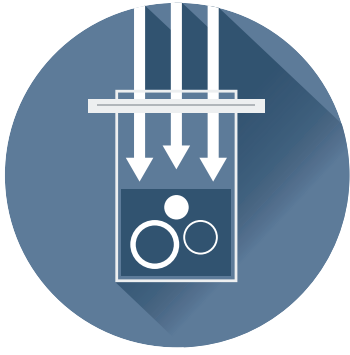

STERILIZED SAMPLE COLLECTING BAGS

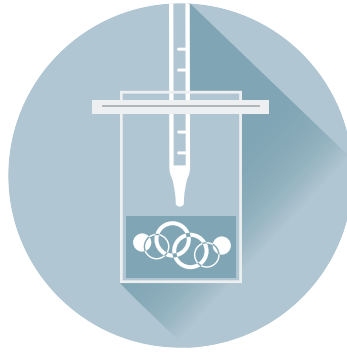

STERILIZED SAMPLE PROCESSING BAGS



SAMPLING COLLECTION TOOLS

STERILIZED SAMPLE COLLECTING BAGS	PGS. 4-17
STERILIZED SAMPLE PROCESSING BAGS	PGS. 18-23
RACKS & ACCESSORIES	PGS. 24-27
SAMPLING COLLECTION TOOLS	PGS. 28-33

Whirl-Pak® sterilized sampling bags are ideal for food & beverage, dairy, water, medical, veterinary, environmental, soil, and industrial markets as well as surface, forensic science, genetics, biomedical, and pharmaceutical sampling.

Whirl-Pak® sterilized sampling bags are R-Nase, D-Nase, Pyrogen and BPH free and comply with regulatory and industrial requirements:



Whirl-Pak® bags have been the professionals' trusted sampling bag for 60 years and offer puncture-proof closure tabs, guaranteed sterility, easy identification, and a leak-proof closure you can rely on.



STERILIZED SAMPLE COLLECTING BAGS

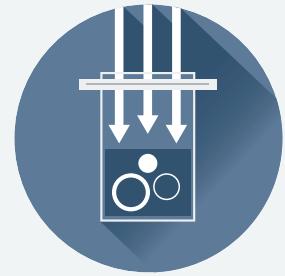

Whirl-Pak® features



- **Puncture-Proof Closure Tabs:** Eliminate sharp points which could puncture the bags, scratch a person's hands, or puncture gloves. The "PUNCTURE-PROOF TABS" process is patented under No. 5,180,229.



- **Guaranteed Sterile: +1 Sterilization®** — process of sterilizing sealed cartons of Whirl-Pak® bags after manufacturing, which is completed at an independent ISO-certified facility.



- **Sterility Traceability:** Download sterility certificates from whirl-pak.com using the lot number and master number on every box.



- **Film:** Exceptionally clear film and superior strength by using co-extrusion low-density and linear low-density, virgin polyethylene.



- **Leak-Proof Closure:** Whirling or folding the bag over three times and securing with the closure tabs creates a leak-proof sampling container.



- **Reduced Storage and Shipping:** Whirl-Pak® bags can save you \$\$\$ as they require less space vs. other sampling containers, which saves on shipping, storage, and waste costs.

500 BAGS VS. 500 BOTTLES

GUARANTEED STERILE
Manufactured according to
quality management systems
ISO9001:2015 & *ISO13485:2016

- o Uses less shelf space
- o Easier disposal
- o Durable
- o Lower shipping costs
- o Built-in closure
- o Lower total cost

*Only bags in the industry
ISO13485:2016 certified



HOW DOES WHIRL-PAK® WORK?

STEP 1

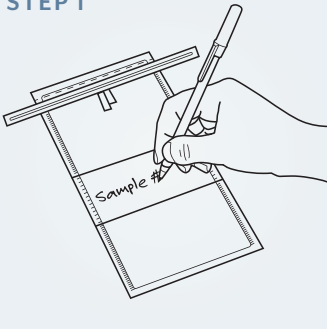

Label your sample if
using a write-on bag.

STEP 2



To open, tear off
the top along the
perforation.

STEP 3



Use the Tyvek® pull
tabs to open without
contamination.

STEP 4

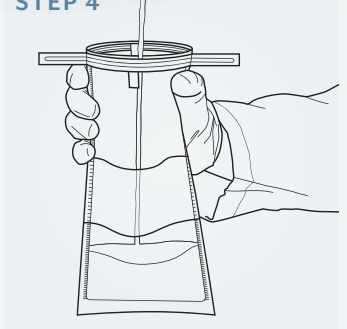

Place sample in bag.
Perfect for liquids
or solids.

STEP 5A

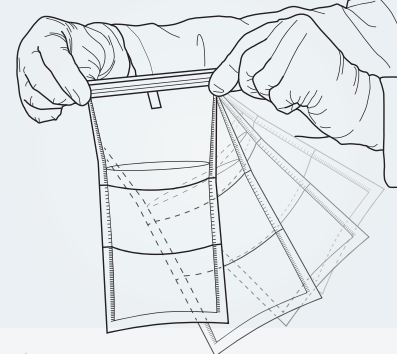

Hold bag by the
tabs and whirl 3 to 4
times to make a seal.

STEP 5B

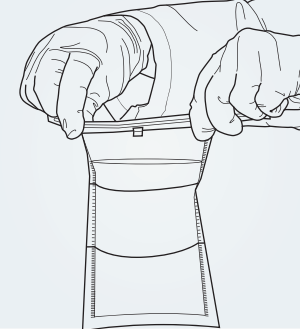

Or, fold the tab
over tightly 3 to 4
times to close.

STEP 6A

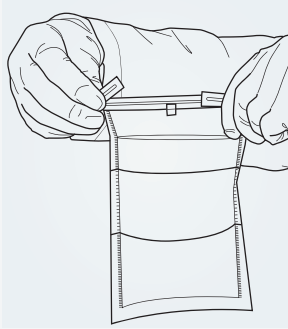

Secure closure,
bend wire ends.

STEP 6B



Or, bring the two wire
ends together and
twist tie them.

STANDARD BAGS

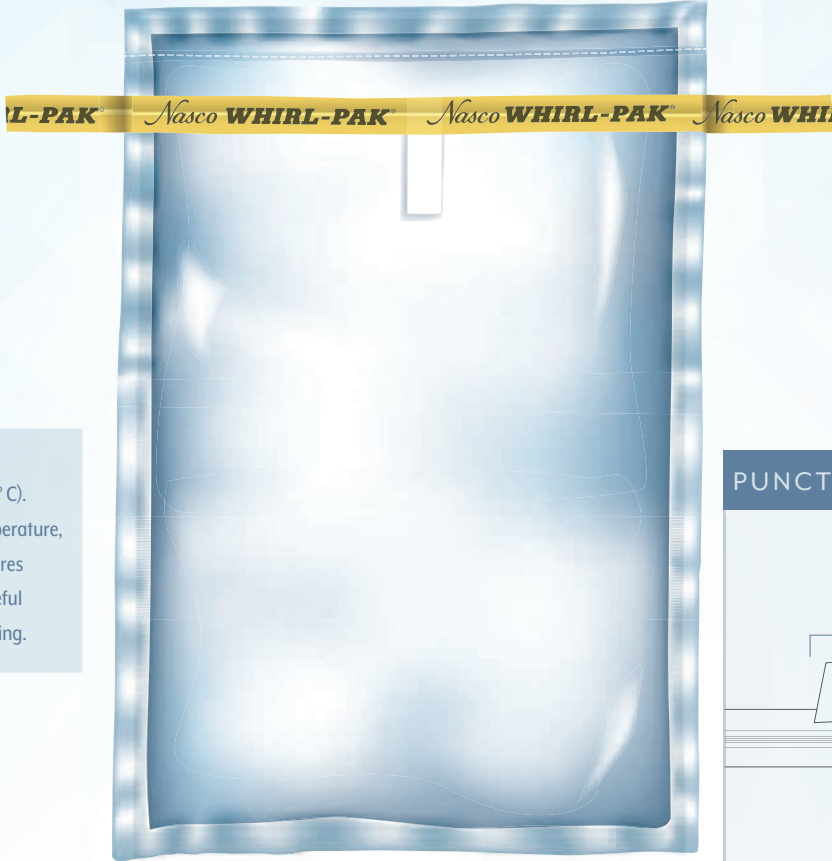

Capacity is measured when the bag is closed and tab is folded over three times. Volume and dimensions are approximate.

Bags should not be used at temperatures above 180° F (82° C). Bags can be frozen to any temperature, even liquid nitrogen temperatures down to -346° F (-210° C) – careful handling is required after freezing.

PUNCTURE-PROOF CLOSURE TABS

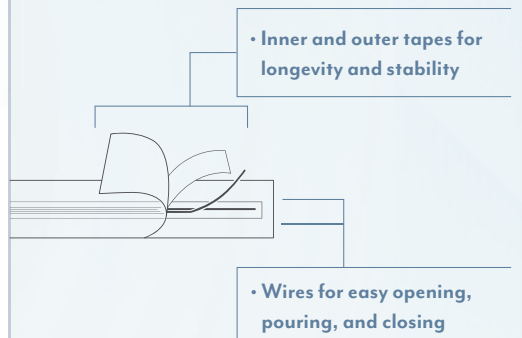

STANDARD BAGS

CAT. NO.	WIRE STYLE	CAPACITY		SIZE		THICKNESS	BAGS/BOX	COMPATIBLE RACK
		OZ.	ML	IN.	CM			
B01009WA	Round	2 oz.	58 ml	3" W x 5" L	7.5 x 12.5 cm	2.25 mils	500	A, B, C, E, I
B00679WA	Round	4 oz.	118 ml	3" W x 7¼" L	7.5 x 18.5 cm	2.25 mils	500	A, B, C, E, G, I
B00992WA	Round	7 oz.	207 ml	3¾" W x 7" L	9.5 x 18 cm	3 mils	500	A, B, C, F, G, I
B01018WA	Round	13 oz.	384 ml	5¼" W x 7½" L	13 x 19 cm	3 mils	500	D, F, H
B00736WA	Round	18 oz.	532 ml	4½" W x 9" L	11.5 x 23 cm	2.5 mils	500	D, F
B01545WA*	Round	18 oz.	532 ml	4½" W x 9" L	11.5 x 23 cm	2.5 mils	500	D, F
B01255WA	Round	24 oz.	710 ml	6" W x 9" L	15 x 23 cm	2.5 mils	500	D, F
B01020WA	Round	24 oz.	710 ml	6" W x 9" L	15 x 23 cm	3 mils	500	D, I
B01063WA	Round	24 oz.	710 ml	6" W x 9" L	15 x 23 cm	4 mils	500	D, H
B00990WA	Round	27 oz.	798 ml	5" W x 12" L	12.5 x 30.5 cm	3 mils	500	D, F, H
B00994WA	Round	36 oz.	1,065 ml	5" W x 15" L	12.5 x 38 cm	3 mils	500	D, F, H
B01027WA	Round	42 oz.	1,242 ml	6" W x 15" L	15 x 38 cm	3 mils	500	H
B01546WA*	Round	42 oz.	1,242 ml	6" W x 15" L	15 x 38 cm	3 mils	500	H
B01532WA	Round	55 oz.	1,627 ml	7½" W x 12" L	19 x 30 cm	3 mils	500	H
B01323WA	Round	69 oz.	2,041 ml	7½" W x 15" L	19 x 38 cm	3 mils	500	H

* Indicates steel wire closure, instead of aluminum.

POST-MANUFACTURING STERILIZATION

- increased sample integrity
- perforated closure to maintain sterility



OPENING PULL TABS

- for easy opening
- non-slip textured Tyvek®



CONVENIENT WRITE-ON STRIP

- makes labeling quick and easy
- clear sample identification
- for organization & traceability



CONTINUOUS PERIMETER SEAL

- maximum protection against leaks

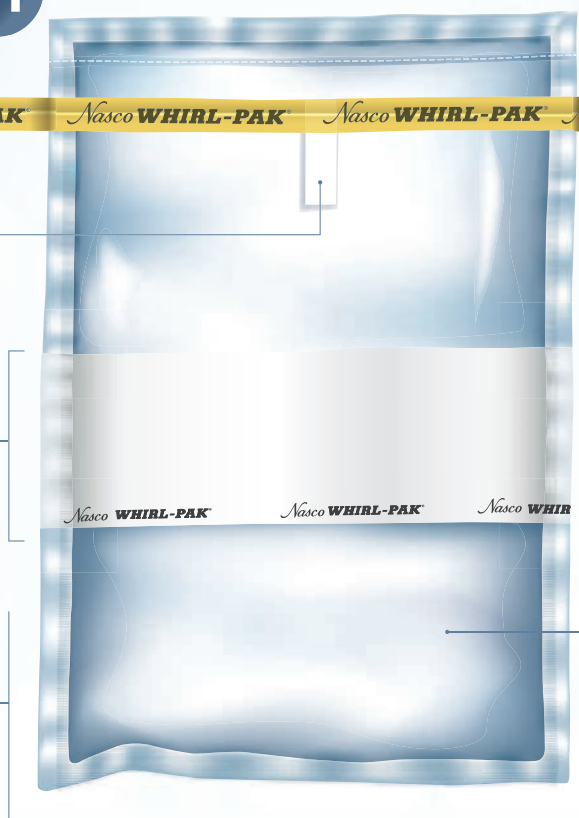

TRUSTED, PUNCTURE-PROOF CLOSURE TABS

- tape extends beyond wire to eliminate sharp ends and provide a sturdy grip
- wire tabs hold the top open for easy access to add to or remove sample
- worry-free, no-leak closure for sample integrity



BLENDED, VIRGIN POLYETHYLENE FILM

- exceptional clarity
- superior strength
- sterilized after manufacturing
- FDA approved for food contact



WRITE-ON BAGS

CAT. NO.	WIRE STYLE	CAPACITY		SIZE		THICKNESS	BAGS/ BOX	COMPATIBLE RACK
		OZ.	ML	IN.	CM			
								SEE PAGE 25
B01067WA	Round	1 oz.	29 ml	2½" W x 5" L	6.5 x 12.5 cm	2.25 mils	500	A, B, C, E, I
B01064WA	Round	2 oz.	58 ml	3" W x 5" L	7.5 x 12.5 cm	2.25 mils	500	A, B, C, E, I
B01339WA	Flat	4 oz.	118 ml	3" W x 7¼" L	7.5 x 18.5 cm	2.25 mils	500	A, B, C, E, G, I
B01062WA ■ ■	Round	4 oz.	118 ml	3" W x 7¼" L	7.5 x 18.5 cm	2.25 mils	500	A, B, C, E, G, I
B01489WA	Round	7 oz.	207 ml	3¾" W x 7" L	9.5 x 18 cm	2.5 mils	500	A, B, C, E, G, I
B01490WA	Round	13 oz.	384 ml	5¼" W x 7½" L	13 x 19 cm	2.5 mils	500	D, F, H
B01065WA ■ ■	Round	18 oz.	532 ml	4½" W x 9" L	11.5 x 23 cm	2.5 mils	500	D, F
B01341WA	Flat	18 oz.	532 ml	4½" W x 9" L	11.5 x 23 cm	2.5 mils	500	D, F
B01297WA ■ ■	Round	24 oz.	710 ml	6" W x 9" L	15 x 23 cm	3 mils	500	D, H
B01196WA	Round	24 oz.	710 ml	6" W x 9" L	15 x 23 cm	4 mils	500	D, H
B01491WA	Round	27 oz.	798 ml	5" W x 12" L	12.5 x 30.5 cm	3 mils	500	D, F, H
B01195WA ■ ■	Round	55 oz.	1,627 ml	7½" W x 12" L	19 x 30 cm	4 mils	500	H
B01515WA	Round	69 oz.	2,041 ml	7½" W x 15" L	19 x 38 cm	3 mils	500	H
B01445WA	1 Flat, 1 Round	92 oz.	2,721 ml	10" W x 15" L	25.4 x 38 cm	4 mils	250	J
B01446WA	1 Flat, 1 Round	123 oz.	3,637 ml	10" W x 20" L	25.4 x 50.8 cm	4 mils	250	K
B01447WA	1 Flat, 1 Round	184 oz.	5,441 ml	15" W x 20" L	38 x 50.8 cm	4 mils	100	L

- Flat wire provides a thicker tab, resulting in a heavier closure.
- For larger bags fold tab over tightly 4-5 times when closing.

(WT) White Tape (BT) Blue Tape (RT) Red Tape

Indicate color by letter code: B01062(WT)WA

THIO-BAGS®



EPA approved for more efficient microbiological water sampling.

Specifically designed for sampling chlorinated water from municipalities, swimming pools, waste water, and other areas to test for fecal coliforms or other bacteria. Each sterile bag contains a nontoxic, nonnutritive tablet containing **active sodium thiosulfate** to neutralize chlorine at the time of collection. The bag is EPA approved and has the additional benefits of saving technician time, utility costs, storage space, and disposal costs by replacing other sample containers. Each sterilized bag has a convenient write-on strip.

POST-MANUFACTURING STERILIZATION

- increased sample integrity
- perforated closure to maintain sterility

OPENING PULL TABS

- for easy opening
- non-slip textured Tyvek®

CONVENIENT WRITE-ON STRIP

- makes labeling quick and easy
- clear sample identification
- fill lines for accurate sample measurement (some sizes come without fill lines)
- for organization & traceability

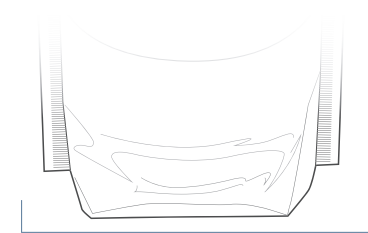

STAND-UP BAGS

- self-standing gusseted bags eliminate the need for racks or holders

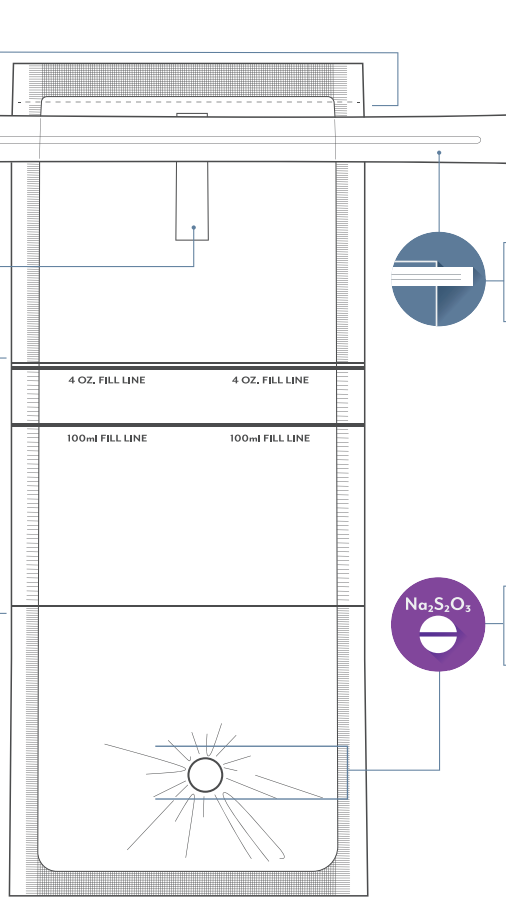

TRUSTED, PUNCTURE-PROOF CLOSURE TABS

- worry-free, no-leak closure for sample integrity
- classic white with purple type closure for easy recognition
- wire tabs hold the top open for easy access to add to or remove sample



THE TABLET IS ALREADY IN THERE

- manufactured with a sodium thiosulfate tablet in the bag for chlorine neutralization

MORE EFFICIENT THAN TRADITIONAL METHODS

- save technician's time
- save on utility, storage, transportation, and disposal costs

introducing new sizes

▣ B01601WA
Stand up 17 oz. (500 ml)

▣ B01603WA
Stand up 34 oz. (1,000 ml)

▣ B01604WA
Stand up 68 oz. (2,000 ml)

STAND UP BAGS

CAT. NO.	WIRE STYLE	CAPACITY		SIZE		THICKNESS	BAGS/POUCH	BAGS/BOX	COMPATIBLE RACK
		OZ.	ML	IN.	CM				
									SEE PAGE 25
B01402WA	Round	4 oz.	100 ml	3" W x 7 1/4" L	7.5 x 18.5 cm	2.5 mils	25	100	A, B, C, E, G, I
B01403WA	Round	10 oz.	300 ml	4 1/2" W x 9" L	11.5 x 23 cm	3 mils	25	100	D, F
▣ B01601WA	1 Flat, 1 Round	17 oz.	500 ml	6" W x 9" L	15 x 23 cm	3 mils	25	100	D, H
▣ B01603WA	1 Flat, 1 Round	34 oz.	1,000 ml	6" W x 15" L	15 x 38 cm	4 mils	25	100	H
▣ B01604WA	1 Flat, 1 Round	68 oz.	2,000 ml	7 1/2" W x 15" L	19 x 38 cm	4 mils	25	100	H

FLAT BAGS

CAT. NO.	WIRE STYLE	CAPACITY		SIZE		THICKNESS	BAGS/POUCH	BAGS/BOX	COMPATIBLE RACK
		OZ.	ML	IN.	CM				
									SEE PAGE 25
B01040WA	Round	4 oz.	100 ml	3" W x 7 1/4" L	7.5 x 18.5 cm	2.25 mils	25	100	A, B, C, E, G, I
B01254WA	Round	10 oz.	300 ml	4 1/2" W x 9" L	11.5 x 23 cm	2.5 mils	25	100	D, F

STAND-UP BAGS



Works like a bottle
without the cost and
storage constraints

▀ These self-standing bags make sample handling easier as they give users the ability to perform important laboratory functions with both hands. The bottom of the gusseted bag unfolds when a sample is placed inside, allowing the bag to stand upright. Stand-up bags function just like a bottle; however, they cost less, come sterilized, are shatterproof, and use only a fraction of the storage and disposal space required by hard-sided containers.

more efficient than bottles

- saves space and money
- durable
- guaranteed sterile
- reduced disposal costs
- easy to recycle

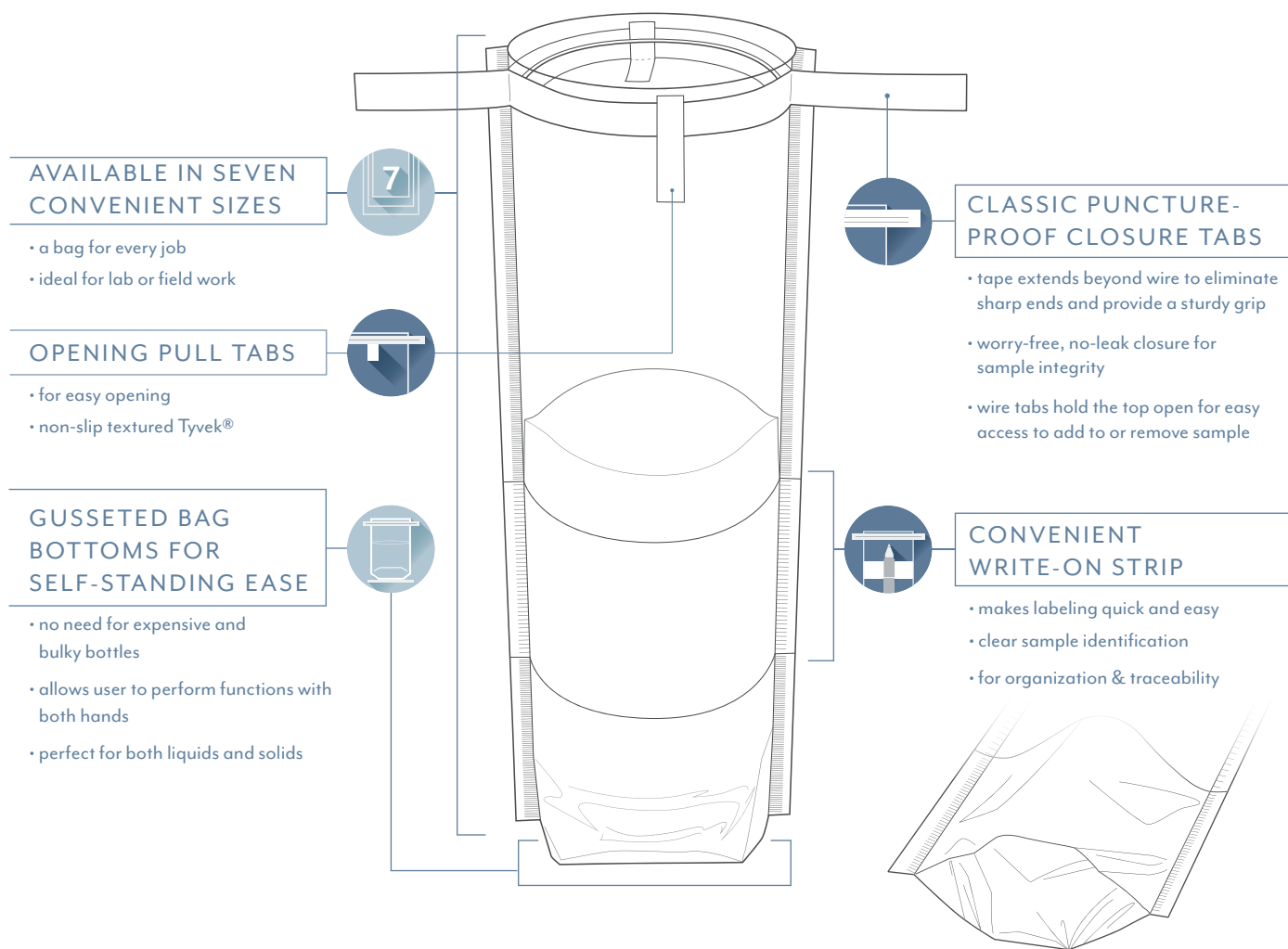

CAT. NO.	WIRE STYLE	CAPACITY		SIZE		THICKNESS	BAGS/BOX	COMPATIBLE RACK
		OZ.	ML	IN.	CM			
B01364WA	Round	4 oz.	118 ml	3" W x 7¼" L	7.5 x 18.5 cm	2.5 mils	500	A, B, C, E, G, I
B01365WA	Round	18 oz.	532 ml	4½" W x 9" L	11.5 x 23 cm	3 mils	500	D, F
B01401WA	Round	24 oz.	710 ml	6" W x 9" L	15 x 23 cm	3 mils	500	D, H
B01449WA	1 Flat, 1 Round	36 oz.	1,065 ml	5" W x 15" L	12.5 x 38 cm	4 mils	250	D, F, H
B01450WA	1 Flat, 1 Round	42 oz.	1,242 ml	6" W x 15" L	15 x 38 cm	4 mils	250	J, K
B01451WA	1 Flat, 1 Round	69 oz.	2,041 ml	7½" W x 15" L	19 x 38 cm	4 mils	250	J, K
B01542WA	1 Flat, 1 Round	138 oz.	4,080 ml	15" W x 15" L	38 x 38 cm	4 mils	100	L

POLYURETHANE SPONGE BAGS

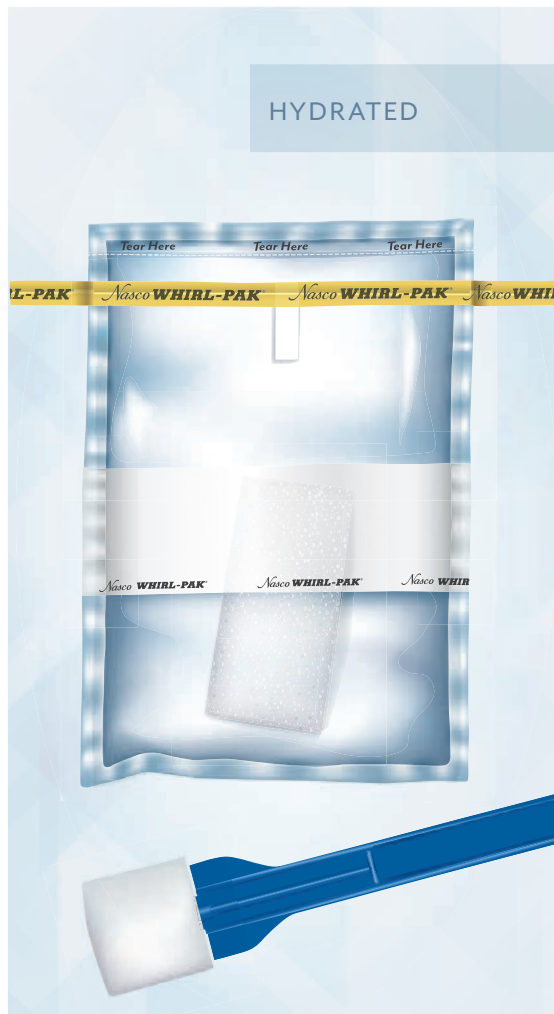

HYDRATED

Welcome to the next generation in environmental surface sampling

▲ Specially designed for use in the food and beverage industry, these polyurethane sponge bags pre-hydrated with HiCap™ Neutralizing Broth provide surface sampling solutions superior to standard collection methods. Medical-grade polyurethane sponges are non-toxic, super absorbent, and more resistant than traditional cellulose sponges, making them ideal for sampling rough surfaces. Hicap™ Neutralizing Broth outperforms traditional broths. It provides superior neutralization, is validated up to 72 hours, is nonallergenic, has a two-year shelf life, and is compatible with 3M™ Petrifilm™.

benefits of polyurethane sponges

- allergen free – no animal components
- non-toxic – no biocides
- consistent – synthetic & high quality
- strength – resistant to tears
- better absorbency and retention
- neutralizes sanitizing solutions

WHIRL-PAK® HYDRATED POLYSPONGE™ BAGS

Each sponge is packed in a sealed 18-oz. (532 ml) write-on bag and is hydrated with 10 ml of HiCap™ Neutralizing Broth. Terminally gamma processed to guarantee sterility. Box contains five foil pouches with 20 sponges each for a total of 100 sponges. Bags are 4½" W x 9" L (11.5 x 235 cm) with a thickness of 2.5 mils (.064 mm). Two-year shelf-life with ambient storage at 36°–86° F (2°–30° C).

- B01590WA Without Glove.**
- B01591WA With Sterile Glove.**



HEAVY-DUTY HANDLE DESIGNED TO HELP CUT THROUGH BIOFILMS

WHIRL-PAK® HYDRATED POLYPROBE™

The 8" (20.3 cm) long bendable polypropylene handle allows maximum contact of the sponge with the sampling surface and also helps with the collection of hard-to-reach surfaces, around corners, and irregularly shaped areas. The innovative twist-off head holds the polyurethane sponge securely and is quick and easy to remove from the handle once sample collection is completed.

The PolyProbe™ is sealed in a 24 oz. (710 ml) write-on Whirl-Pak® bag and hydrated with 10 ml of HiCap™ Neutralizing Broth. Bags are 6" W x 9" L (15 x 23 cm) with a thickness of 2.5 mils (.064 mm). Two-year shelf life with ambient storage at 36°–86° F (2°–30° C). Box contains five foil pouches with 20 probes each for a total of 100 probes.

B01592WA

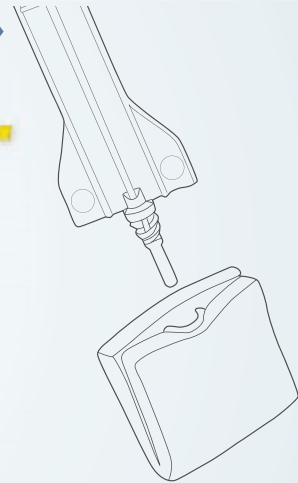

HiCap™ is a trademark of World Bioproducts, LLC.

HICAP™
BROTH

VS.

TRADITIONAL
COLLECTION
BROTHS

CHARACTERISTIC	HICAP™ NEUTRALIZING BROTH	NEUTRALIZING BUFFER	LETHEEN BROTH	D/E NEUTRALIZING BROTH
Quat Neutralization	Highest	Moderate	Weakest	Highest
Free Chlorine Neutralization	Highest	Weakest	Moderate	Highest
High Acid Neutralization	Highest	Weakest	Weakest	Highest
Peroxyacetic Acid Neutralization	Highest	Yes	Yes	Highest
All components listed on EAFUS as acceptable for use in food	Yes	Yes	Yes	No
All components compatible with 3M™ Petrifilm™	Yes	Yes	Yes	No
All components nonallergenic	Yes	Unknown	Unknown	No
Compatible with molecular detection assays	Yes	Yes	Yes	Yes
Stable at ambient storage temp.	Yes	Yes	Yes	Yes

CELLULOSE SPONGE BAGS



HYDRATED OR DRY

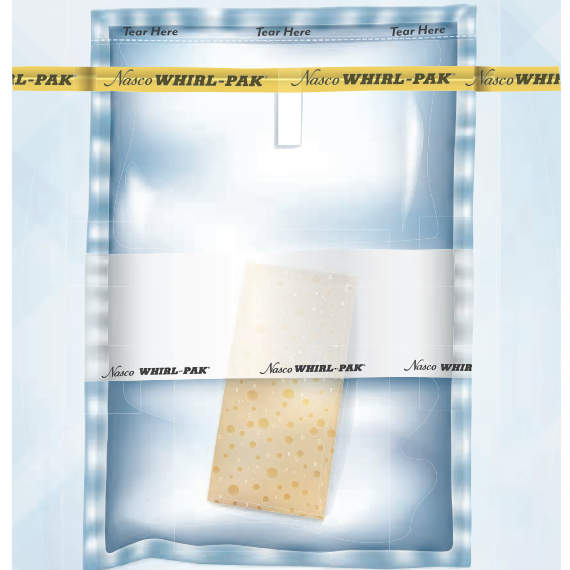

An environmental surface sampling standard

▣ Designed for environmental surface sampling of work areas, equipment, animal carcasses, and any other place where testing for *Listeria*, *Salmonella*, *E.coli*, coliforms and other foodborne pathogens, or anthrax is required. The special natural cellulose dry sponge is free of bactericides and has been tested to be non-inhibitory. Wearing a sterile glove when wiping with the sponge is recommended to help prevent contamination.

WHIRL-PAK® SPECI-SPONGE® (HYDRATED)

Cellulose sponge, hydrated with 10 ml of neutralizing buffer. The buffer will neutralize surface sanitizers, including quaternary ammonium compounds, phenolics, iodine preps, chlorine preps, mercurials, formaldehyde, and glutaraldehyde.

B01423WA contains a size large, sterile glove in a separate compartment. Both bags are 4½" W x 9" L (11.5 x 23 cm) with 18 oz. (532 ml) capacity, and 2.5 mils (.064 mm) film thickness. Gamma radiated. Box of 100.

Diluent has a 24-month shelf life from the date of manufacture. Neutralizing buffer contains monopotassium phosphate, sodium thiosulfate, and aryl sulfonate complex.

- B01422WA Without Glove.**
- B01423WA With Sterile Glove.**



USE YOUR OWN BUFFER

WHIRL-PAK® SPECI-SPONGE® (DRY)

18-oz. (532 ml) Speci-Sponge® Bag
Size: 4½" W x 9" L (11.5 x 23 cm).
Film thickness: 2.5 mils (.064 mm). Box of 100.

B01245WA
55-oz. (1,627 ml) Speci-Sponge® Bag Size: 7½" W x 12" L (19 x 30 cm) – perfect for use with homogenizer blenders.
Film thickness: 4.0 mils (.102 mm). Box of 100.

B01299WA
18-oz. Speci-Sponge® Bag with Sterile Glove
Includes a sterile, size large polyethylene glove attached in a bottom compartment.
Bag thickness is 2.5 mils (.064 mm).
Bag size: 4½" W x 9" L (11.5 x 23 cm). Box of 100.

B01392WA



USE YOUR OWN BUFFER

WHIRL-PAK® SPONGE PROBE (DRY)

The 8" (20.3 cm) long bendable polypropylene handle allows maximum contact of the sponge with the sampling surface and also helps with the collection of hard-to-reach surfaces, around corners, and irregularly shaped areas. The innovative twist-off head holds the cellulose sponge securely and is quick and easy to remove from the handle once sample collection is completed. Sterilized 24-oz. (710 ml) write-on bag. Box of 50.

B01475WA

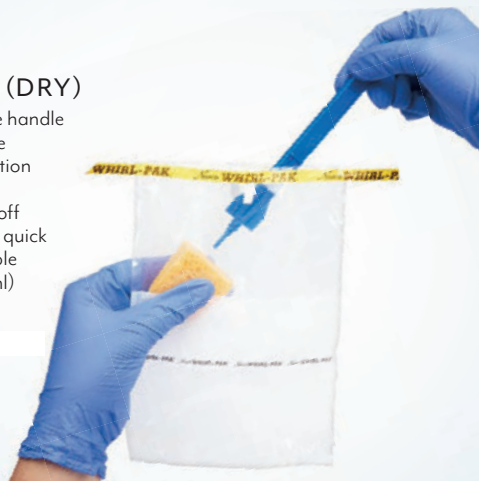

accessories



NASCO SPONGE POLE WITH DETACHABLE SPONGE HOLDER

For hard to reach places, the adjustable aluminum pole extends from 6 ft. (1.83 m) to 12 ft. (3.66 m) long. Sponge holder is autoclavable. Optional Probe Adapter (B01593WA) sold separately. Sponges not included.

B01457WA

B01559WA Replacement Sponge Holder.

B01351WA Non-Sterile Bulk Sponges.
Bag of approximately 250.

Probe Adapter. Designed for use with the Whirl-Pak® Sponge Probe or PolyProbe™. Threaded aluminum adapter can be easily and securely attached to most available extension poles in the market, including the Nasco Sponge Pole (B01457WA).

B01593WA

CAT. NO.	WIRE STYLE	STYLE	CAPACITY		SIZE		THICKNESS	BAGS/BOX
			OZ.	ML	IN.	CM		
B01245WA	Round	Dry	18 oz.	532 ml	4½" W x 9" L	11.5 x 23 cm	2.5 mils	100
B01299WA	Round	Dry	55 oz.	1,627 ml	7½" W x 12" L	19 x 30 cm	4 mils	100
B01392WA	Round	Dry w/glove	18 oz.	532 ml	4½" W x 15" L	11.5 x 38 cm	2.5 mils	100
B01475WA	Round	Dry Sponge Probe	24 oz.	710 ml	6" W x 9" L	15 x 23 cm	3 mils	50
B01422WA	Round	Hydrated	18 oz.	532 ml	4½" W x 9" L	11.5 x 23 cm	2.5 mils	100
B01423WA	Round	Hydrated w/glove	18 oz.	532 ml	4½" W x 15" L	11.5 x 38 cm	2.5 mils	100

SPECIALTY BAGS



WHIRL-PAK® EXCLUSIVE SCOOP BAG



Solutions for all your sampling needs

From blackout material to the inclusion of sterile tools, these specialty bags are designed with specific features to make sample collection in every industry convenient and more efficient.



WHIRL-PAK® SPOON BAG

18-oz. (532 ml) write-on bag contains a sterile, disposable polystyrene plastic spoon of approximately 1 teaspoon capacity. Box of 100.

B01478WA

B01041(A)WA Bulk Sterilized Spoons.

5 pkgs of 20. Box of 100.

WHIRL-PAK® SCOOP BAG

The 2-oz. (60 cc) polypropylene scoop measures 7" (18.5 cm) long, and comes sterilized in an 18-oz. (532 ml) bag. Film thickness: 2.5 mils (.064 mm). Box of 50 bags.

B01350WA White Scoop

B01350(B)WA Blue Scoop



NASCO MEAT/POULTRY CARCASS SAMPLING KIT

Contains a pair of sterile polyethylene gloves, 25 ml buffered peptone water (**the peptone water has an expiration date marked on the box**), a sterile Whirl-Pak® Speci-Sponge® bag, and two disposable sterile templates, one for meat carcasses (10 x 10 cm) and one for poultry (5 x 10 cm). The disposable template eliminates the need for re-sanitizing reusable templates, saving time and money. The flexible heavy paper templates form to the contours of the carcass, making it easier to swab within the required area. The gloves and templates are packaged together in a sealed plastic bag that has a perforation for easy opening.

Box of 25 kits.

B01324WA

Templates and Gloves Only. 100 individually packaged and sterilized kits containing one meat template, one poultry template, and one pair of gloves.

B01378WA



WHIRL-PAK® BLACK BAG

This opaque bag provides maximum protection for samples that are sensitive to light. Ideal for pharmaceuticals, spinal fluid, amniotic fluid, seasonings, flavors, food supplements, vitamins, marine life, and many other liquid or solid samples. FDA approved for food contact. Box of 500 bags.

B01472WA 4 oz. (118 ml). Film thickness 2.5 mils (.064 mm).

B01418WA 18 oz. (532 ml). Film thickness 2.5 mils (.064 mm).

B01558WA 55 oz. (1,627 ml). Film thickness 4.0 mils (.102 mm).

POCKET BAG

The pocket on this 24-oz. (710 ml) bag measures 5 $\frac{3}{8}$ " W x 5 $\frac{5}{8}$ " L (13.7 x 14.2 cm) and keeps important paperwork dry, clean, and separate from the sample. Bag measures 6" W x 9" L (15 x 23 cm). Film thickness: 2.5 mils (.064 mm). Box of 500 bags.

B01255WA



NASCO POULTRY RINSE BAG

For use following USDA instructions for poultry sampling, testing for E. coli., this polyethylene bag measures 15" W x 20" L (37.5 x 50 cm), is sealed at the top to maintain sterility, and has a perforation for easy opening. Holds small turkeys, chickens, and other similar size poultry. Film thickness: 2.0 mils (.051 mm). Box of 250 bags.

B01319WA



STERILIZED SAMPLE PROCESSING BAGS

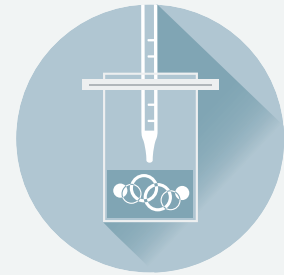

Whirl-Pak® features



- **Puncture-Proof Closure Tabs:** Eliminate sharp points which could puncture the bags, scratch a person's hands, or puncture gloves. The "PUNCTURE-PROOF TABS" process is patented under No. 5,180,229.



- **Guaranteed Sterile:** +1 Sterilization® — process of sterilizing sealed cartons of Whirl-Pak® bags after manufacturing, which is completed at an independent ISO-certified facility.



- **Sterility Traceability:** Download sterility certificates from whirl-pak.com using the lot number and master number on every box.



- **Film:** Exceptionally clear film and superior strength by using co-extrusion low-density and linear low-density, virgin polyethylene.



- **Leak-Proof Closure:** Whirling or folding the bag over three times and securing with the closure tabs creates a leak-proof sampling container.



- **Reduced Storage and Shipping:** Whirl-Pak® bags can save you \$\$\$ as they require less space vs. other sampling containers, which saves on shipping, storage, and waste costs.

PLAIN BLENDER BAGS

When the sample does not have to be retained, these bags are designed for quick testing and disposal. The bags are made of Whirl-Pak® film, have a perimeter seal, and are sealed at the top. There is a perforation for easy opening and to protect sterility, which allows for separate handling of each bag.

7½" W x 12" L (19 x 30 cm).

55 oz. (1,627 ml). Thickness 3.0 mils (.076 mm). Box of 1,000 bags.

B01421WA

15" W x 20" L (37.5 x 50 cm).

184 oz. (5,441 ml). Thickness 4.0 mils (.102 mm). Box of 250 bags.

B01474WA



LOCKING CLOSURES

These handy, cost-effective locking pipes provide an air- and watertight closure for bags without traditional tape and wire closure. Autoclavable. Pack of 50 nonsterile closures.

9" Pipe Closures. Use these locking pipes with 55 oz. (1,627 ml) and 69 oz. (2,041 ml) blender bags without tape and wire closure to save money. Yellow pipe is 9" L; white pipe is 7¾" L.

B01550WA

7¼" Pipe Closures. Yellow pipe is 7¼" L; white pipe is 6¾" L.

B01595WA



ROUND BOTTOM SEAL

Designed to minimize sample fragments getting caught in the corners of the bag during blending. 52 oz. (1,538 ml). 7" W x 13" L (18.5 x 33 cm). Thickness 4 mils. Box of 500.

B01239WA



NASCO PIPETTE FILTER SLEEVE

Prevents solids from plugging the tip of the pipette when sampling liquids that may contain solid particles. Half of the sleeve is made with the 330 micron hole size filter material. The pipette slides into the sterilized sleeve and is inserted into the liquid to be tested. The liquid will pass through the filter, but not the solids. The sleeve is sized to hold a 10 ml pipette. Each pack of 25 comes packaged in a sterilized Whirl-Pak® bag, which can be closed after each use. Box of 20 packs (500 sleeves).

B01523WA

FULL-PAGE FILTER BAGS

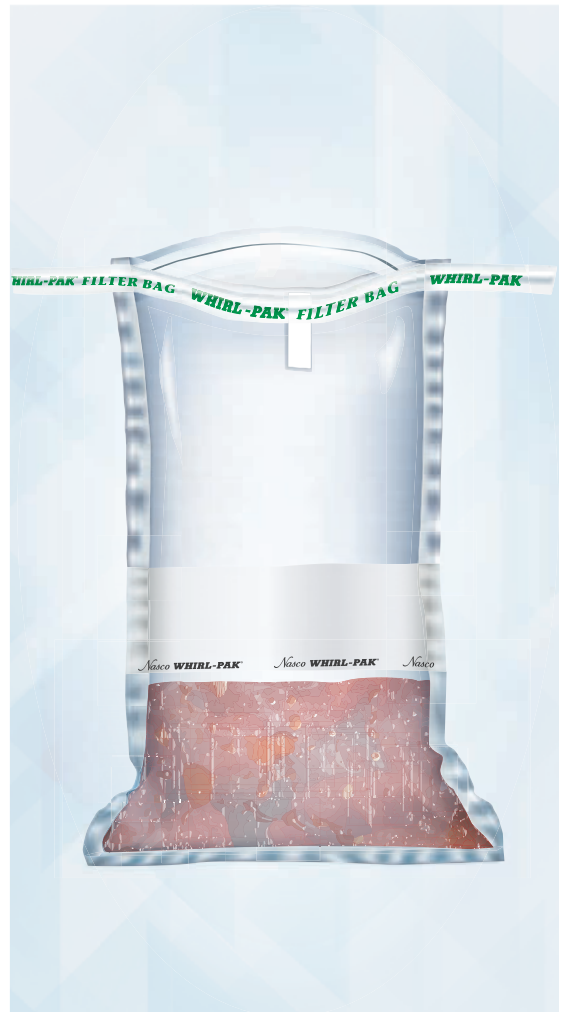

Full-page filter bags perfect for collecting, blending, and pipetting

Filter Bags contain a middle layer of finely perforated polyethylene film, which filters out solids in the blended sample, allowing for clean plate pipetting. The hole diameter in the filter layer measures .013 inches (.33 mm), 330 microns, and there are 1,840 holes per square inch (285 per square cm). The filter layer inside the bag is sealed into the sides and bottom perimeter, allowing the sample to be placed in the bag on either side. Liquids of a blended sample will transfer through the filter, while solids remain separate and contained.

FILTER BAG WITH PUNCTURE-PROOF CLOSURE TABS

- can incubate
- retain samples

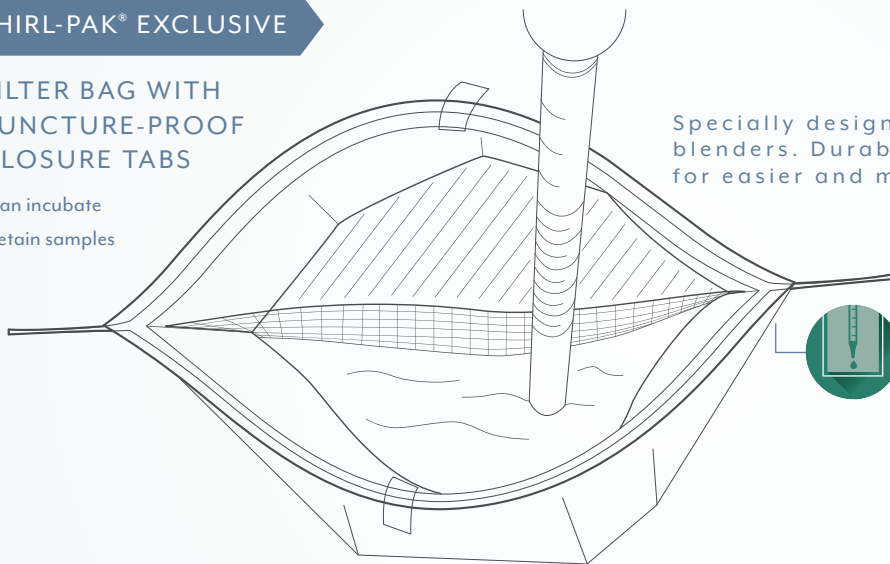

Specially designed for use with homogenizer blenders. Durable PE film and special features for easier and more efficient testing.

FULL-PAGE POLYETHYLENE FILTER

- 330 micron filter layer
- available with or without closure
- collect, blend, and incubate samples with one bag



Filtered



Non-filtered

Filtered samples allows for clean plate pipetting so that you can count colonies instead of debris.

CAT. NO.	WIRE STYLE	CAPACITY		SIZE		THICKNESS	BAGS/BOX
		OZ.	ML	IN.	CM	MILS	
B01385WA	Round	7 oz.	207 ml	3¾" W x 7" L	9.5 x 18 cm	3 mils	250
B01348WA	Round	24 oz.	710 ml	6" W x 9" L	15 x 23 cm	4 mils	250
B01547WA (NO CLOSURE)	No Wire	55 oz.	1,627 ml	7½" W x 12" L	19 x 30 cm	4 mils	250
B01318WA	Round	55 oz.	1,627 ml	7½" W x 12" L	19 x 30 cm	4 mils	250
B01416WA	Round	69 oz.	2,041 ml	7½" W x 15" L	19 x 38 cm	4 mils	250
B01488WA	1 Flat, 1 Round	92 oz.	2,721 ml	10" W x 15" L	25.4 x 38 cm	4 mils	100
B01525WA	1 Flat, 1 Round	138 oz.	4,080 ml	15" W x 15" L	37.5 x 37.5 cm	4 mils	100

VERTICAL FILTER BAGS

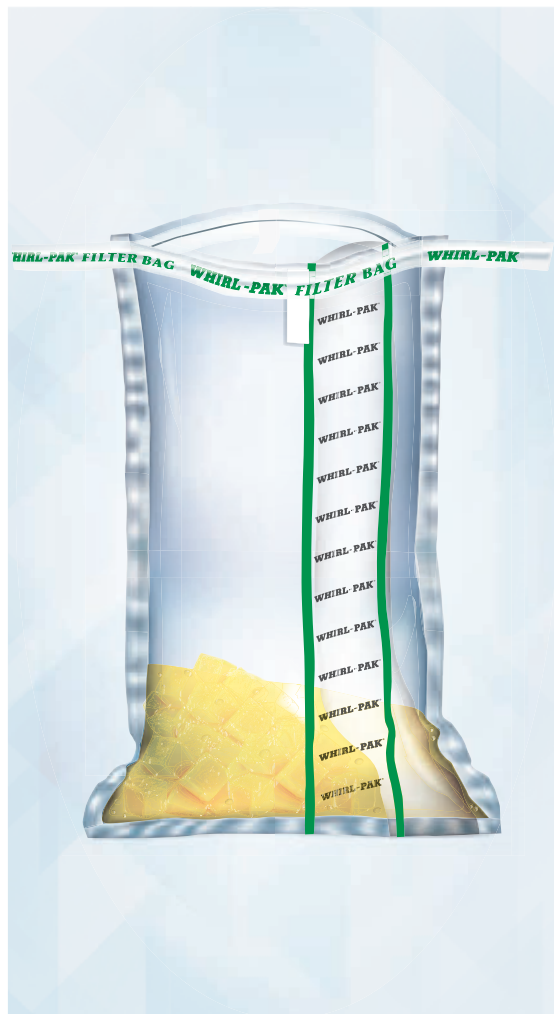

Better blending and pipetting with our vertical, nonwoven filter bags

▀ Bags use a special laminated PET film for durability and a vertical nonwoven filter to separate solids for easy pipetting of the liquid sample. Available with or without a closure, each bag contains a 250 micron polyester filter adhered vertically along the side of the bag.

WHIRL-PAK® EXCLUSIVE

FILTER BAG WITH PUNCTURE-PROOF CLOSURE TABS

- can incubate
- retain samples

Specially designed for use with homogenizer blenders. Durable PET film and special features for easier and more efficient testing.

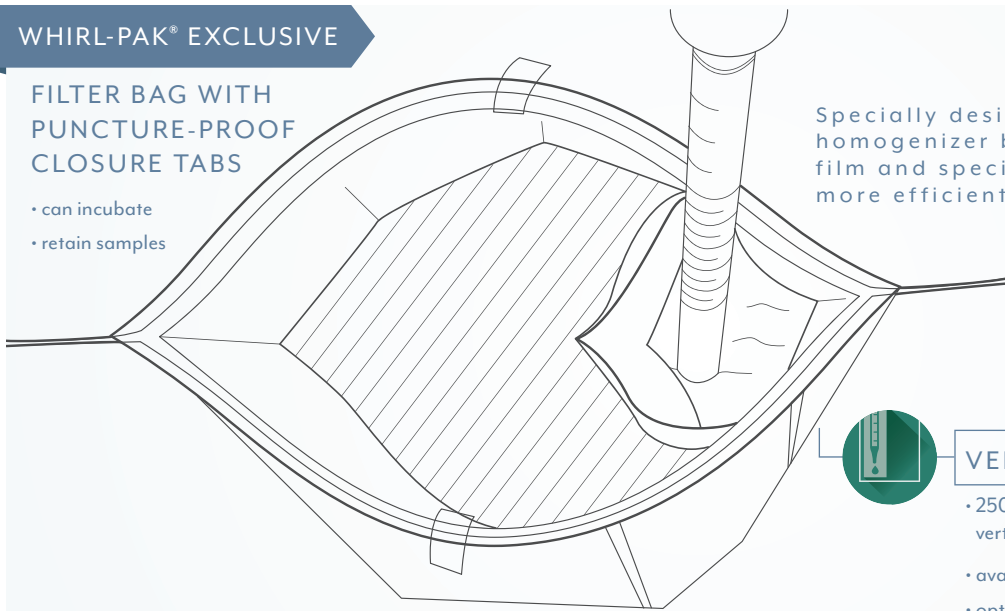

VERTICAL POLYESTER FILTER

- 250 micron polyester filter adhered vertically along one side
- available with or without closure
- optional side seal for convenient pouring

EASY-POUR SIDE SEAL INDICATED BY DOTTED LINES

- allows for simple liquid pour without emptying solids

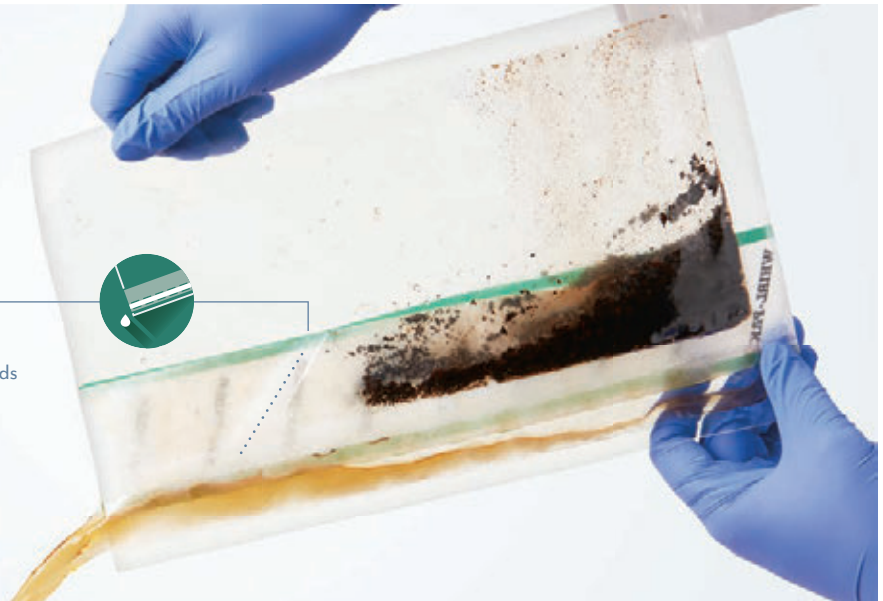

	CAT. NO.	WIRE STYLE	CAPACITY		SIZE		THICKNESS	BAGS/BOX
			OZ.	ML	IN.	CM		
WITH CLOSURE	B01586WA	Round	55 oz.	1,627 ml	7½" W x 12" L	19 x 30 cm	3 mils	250
	B01587WA (POUR SEAL)	Round	55 oz.	1,627 ml	7½" W x 12" L	19 x 30 cm	3 mils	250
	B01588WA	Round	69 oz.	2,041 ml	7½" W x 15" L	19 x 38 cm	3 mils	250
	B01589WA	1 Flat, 1 Round	92 oz.	2,721 ml	10" W x 15" L	25.4 x 38 cm	3 mils	100
NO CLOSURE	B01582WA	No Wire	55 oz.	1,627 ml	7½" W x 12" L	19 x 30 cm	3 mils	250
	B01583WA (POUR SEAL)	No Wire	55 oz.	1,627 ml	7½" W x 12" L	19 x 30 cm	3 mils	250
	B01584WA	No Wire	69 oz.	2,041 ml	7½" W x 15" L	19 x 38 cm	3 mils	250
	B01585WA	No Wire	92 oz.	2,721 ml	10" W x 15" L	25.4 x 38 cm	3 mils	100

WHIRL-PAK® RACKS



▀ Specially designed to hold various sizes of Whirl-Pak® bags. Made in the U.S.A. of 10- and 12-gauge steel fused together to create strong joints and straight lines. Racks are finished with an electrostatically applied powder coating. The result is a strong, durable finish which will stand up to many laboratory materials, and racks that can be autoclaved. Max dry temperature is 300° F (148° C) and wet temperature is 500° F (260° C). The B01048WA rack can also be used for plate incubation by turning it on one side.

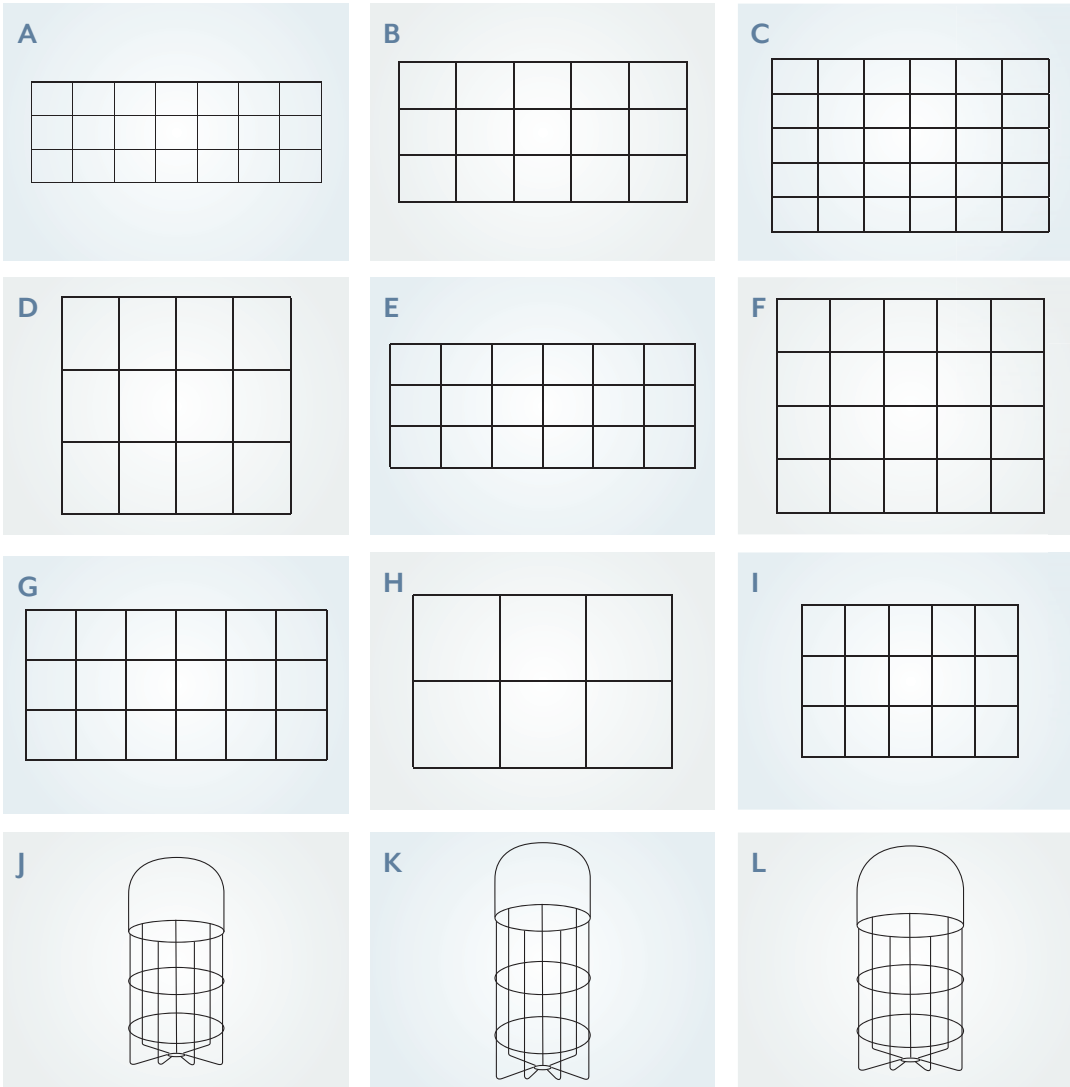

Racks E and I fit Playmate® Coolers



RACK HANDLE

Universal rack handle fits all sizes of racks, making it easy to carry a full rack in one hand. Lightweight, strong, and comfortable to hold. Attaches and detaches easily and quickly, so it never gets in the way. Designed to prevent rack from tipping while it's carried. Overall length: 18" (45.7 cm).

B01309WA

RACK CAT. NO.	RACK SIZE		COMPARTMENTS	COMPARTMENT SIZE	
	IN.	CM		IN.	CM
A. B00677WA*	6½" x 12½" x 3"	16.5 x 31.8 x 7.6	21	1⅝" x 2"	4 x 5
B. B00678WA*	6½" x 9" x 3"	16.5 x 23 x 7.6	15	1⅝" x 2"	4 x 5
C. B00750WA	9¾" x 10⅝" x 3"	24.8 x 27 x 7.6	30	1½" x 2"	3.8 x 5
D. B00751WA	10" x 10" x 3½"	25.4 x 25.4 x 9	12	3" x 2⅞"	7.6 x 6
E. B00772WA* Fits regular-size Playmate® Cooler	6½" x 10¾" x 3"	16.5 x 27.3 x 7.6	18	1⅝" x 2"	4 x 5
F. B01014WA	13⅜" x 10⅞" x 4"	34 x 27 x 10.2	20	2½" x 2½"	6.4 x 6.4
G. B01023WA	6½" x 12¾" x 3"	16.5 x 32.4 x 7.6	18	2" x 2"	5 x 5
H. B01048WA	13¾" x 9¼" x 4½"	35 x 23.5 x 11.4	6	4½" x 4½"	11.4 x 11.4
I. B01109WA Fits little Playmate® Cooler	8¼" x 6" x 3¼"	21 x 15.2 x 8.3	15	1¾" x 1½"	4.4 x 3.8
J. B01533WA With handle	7" dia. x 10" H	17.8 dia. x 25.4 H	1	7" dia. x 10" H	17.8 dia. x 25.4 H
K. B01534WA With handle	7" dia. x 12" H	17.8 dia. x 30 H	1	7" dia. x 12" H	17.8 dia. x 30 H
L. B01535WA With handle	9" dia. x 12" H	23 dia. x 30 H	1	9" dia. x 12" H	23 dia. x 30 H

* Indicates compatible with Nasco Sample Ice Chest (C06115WA), see page 26 for chest.

SPECIALTY ACCESSORIES



WHIRL-PAK® TRANS-PAK® SPECIMEN BAG (NON STERILE)

Outside pouch keeps important paperwork dry, clean, and separate from the sample. Trans-Pak® also features the Biohazard symbol required by OSHA (Occupational Safety and Health Administration). Bag measures 6" W x 9" L (15 x 23 cm). 24 oz. (710 ml). Box of 500. Pouch measures 5 $\frac{3}{8}$ " W x 5 $\frac{3}{4}$ " L (13.7 x 14.6 cm).

B01253WA



SECURITY TAPE STRIPS

Make Trans-Pak® specimen bags and other containers tamperproof with this unique security label. Provides immediate evidence of tampering. Made of a destructible material with a permanent adhesive back that tears when removal is attempted — it's impossible to remove this label in one piece. Set up time for tape is approximately 2 $\frac{1}{2}$ hours. Label size: 1 $\frac{3}{8}$ " W x 6 $\frac{5}{8}$ " L (3.4 x 16.6 cm). Pkg. of 100 labels.

B01240WA



NASCO SAMPLE ICE CHEST

Designed specifically for temperature control and proper protection of samples.

Features:

- Outside and inside walls made of extremely durable, ABS plastic
- Polyurethane foam insulation in walls and lid
- Recessed carrying grips
- Auxiliary ice storage compartment to keep samples cool
- Dimensions with lid: 16" L x 14 $\frac{3}{4}$ " W x 9 $\frac{1}{2}$ " H (40.6 x 37.5 x 24.1 cm)
- Inside dimensions: 12 $\frac{1}{4}$ " L x 13 $\frac{3}{8}$ " W x 7" H (31.12 x 35.3 x 17.8 cm)
- Color: green

C06115WA Ice Chest with Lid.

C06115(A)WA Lid only.

Nasco Racks for Ice Chest. These racks hold 4-oz. (118 ml) bags and fit into the Nasco Sample Ice Chest above (C06115WA). See rack dimensions on page 25.

B00678WA 15-Compartment Rack.

B00772WA 18-Compartment Rack.

B00677WA 21-Compartment Rack.



IMPULSE BAG SEALER

For a permanent seal on a Whirl-Pak® Bag, this tabletop thermal impulse sealer provides a quick, efficient means for sealing any type of thermoplastic film. Provides air- and watertight seals. Maximum seal size is 8" (20 cm). 110V, 260 watts. **220V available through special order.**

B01311WA

Heat Strip Replacement Kit.

Heat strip replacement kit for bag sealer, above. Kit includes two upper hook-and-loop strips, one lower hook-and-loop strip, and two element wires.

B01444WA

individually packaged in sterile bags for secure delivery

A. STERILEWARE® STERILIZED MINI-TONGS

This sterile, compact tool will pick up a variety of samples preventing contamination in the process. The ridged inside surface assures a secure grip. Individually packaged to protect sterility. Made of polystyrene. Box of 25, 4¼" (10.8 cm) L.

B01409WA



B. STERILEWARE® STERILIZED SPOON

Designed to gather small amounts of sample material. The long handle permits easy reaching into confined areas and keeps hands away from the sample. Made of polystyrene. Spoon is 7" (17.8 cm) long. Individually packed in a polyethylene bag and sterilized. 1 tbsp. (14.17 ml) capacity. Case of 200 spoons.

B01306WA



C. STERILEWARE® STERILIZED SAMPLING SPOON

For sampling semi-solids, viscous liquids, or bulk materials, this large, sterile, polystyrene spoon is strong and easy to handle. It has a bowl size of 0.85 oz. (25 ml) and is 10" (25.4 cm) long. Individually packaged to protect sterility. Box of 25.

B01408WA



D. STERILEWARE® STERILIZED SCOOPS

One-piece molded polystyrene scoops with extra-long handles have the perfect shape for rapid sampling. Rounded contours prevent material retention. Case of 100, individually wrapped.

B01159WA 8" (20.3 cm) Scoop.

2-oz. (60 ml) capacity.

B01160WA 8⅞" (22.1 cm) Scoop.

4-oz. (125 ml) capacity.

B01161WA 8½" (21.6 cm) Scoop.

8-oz. (250 ml) capacity.



E. STAINLESS STEEL SCOOP

This stainless steel scoop has a capacity of 5 oz. (148 ml). Perfect for sampling powder, soil, gravel, and other materials. Scoop is 2½" W x 9" L (6.4 x 23 cm). Pack of 12.

B01344WA



F. STERILIZED PLASTIC SCOOPS, EXTRA LARGE

Each scoop has been carefully washed to EPA protocol B for environmental application, then dried, individually sealed in a poly bag, and sterilized by gamma radiation for food, pharmaceutical, and other applications.

B01459WA 16-oz. (472 ml) Polyethylene Scoop.

Round bottom. Pack of 50 scoops.

B01460WA 32-oz. (946 ml) Polystyrene Scoop.

Flat bottom. Pack of 25 scoops.

B01461WA 82-oz. (2,425 ml) Polystyrene Scoop.

Flat bottom. Pack of 24 scoops.



SAMPLING COLLECTION TOOLS

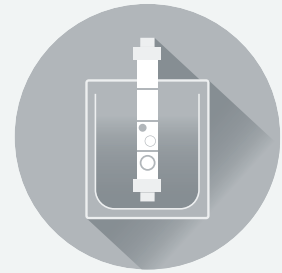

Collection Tools

A variety of specially designed tools and accessories to make sample collection in any industry easy and accurate.



NASCO SLUDGE NABBER

Make sample collection of liquids fast and easy. Adjustable aluminum pole that extends from 4 to 6½ feet (1.22 to 1.99 m). Bottles of various sizes (250 ml to 1,000 ml) can be placed on a polyurethane base and held in place by an adjustable, plastic locking ring. Sanitize only. Do not autoclave. Unit comes with one 500 ml polyethylene bottle. See accessories below. One-year warranty.

B01229WA



B01310WA

B01456WA

NASCO SWING SAMPLER

- The end of the sampler swings 90°.
- Telescoping fiberglass pole extends to various lengths.
- Unit comes with a 960 ml polyethylene bottle and the cover has a vinyl liner for leak-proof protection. Bottles of various sizes (250 ml to 1,000 ml) can be placed on a polyurethane base and held in place by an adjustable, plastic locking ring. Sanitize only. Do not autoclave. One-year warranty.

6 ft.-12 ft. (1.83 m-3.66 m) Swing Sampler.

B01310WA

8 ft.-24 ft. (2.44 m-7.32 m) Swing Sampler.

B01366WA

REPLACEMENT PARTS

6 ft.-12 ft. Pole Plastic Grip.

B01529WA

6 ft.-12 ft. Pole Lock Replacement.

For use with B01310WA and B01367WA.

B01456WA

8 ft.-24 ft. Pole Lock Replacement. For use with B01366WA.

B01527WA

Replacement Threaded Tip. For use with 6-ft. and 8-ft. poles.

B01531WA

Bottle Holder.

B01354WA

Wide-Mouth Bottles. Made from a food-grade, high-density polyethylene. They are recyclable, but not sterile or autoclavable. The plastic caps have a vinyl liner to ensure a tight fit.

B01243WA 500 ml bottle. Pkg. of 12.

B01244WA 960 ml bottle. Pkg. of 12.

Snapper Attachments. Durable plastic locking rings hold sample bottle securely.

Small Snapper. Holds 500 ml bottle.

B01219WA

Large Snapper. Holds 960 ml bottle.

B01220WA



B01367WA

NASCO SAMPLING POLE/LINE FOR WHIRL-PAK® BAGS

Specially designed to hold any size bag, the holder uses a retainer ring to secure the bag firmly in place. Even in a fast flowing stream, the bag will not come loose. The adjustable fiberglass pole extends from 6 to 12 ft. (1.82 to 3.66 m), has a swinging end, and comes with three sizes of retainer rings to hold the bag. Sanitize with a bleach and water mixture. Cannot be autoclaved.

B01367WA

Replacement Bag Holder and Retainer Rings.

For use with Sampling Pole B01367WA.

B01380WA

Nasco Sampling Line for Whirl-Pak® Bags.

Nylon sampling line 25 ft. (7.62 m) with bag holder (see description above).

B01368WA

NASCO SLUDGE JUDGE®

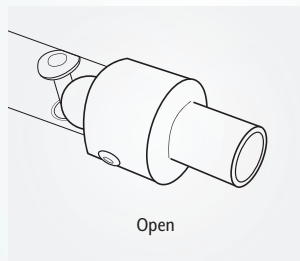

Open

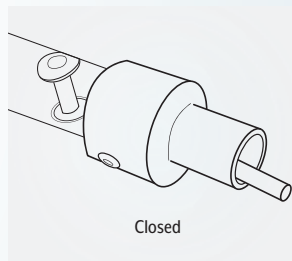

Closed

THE SLUDGE JUDGE®

- Designed to take accurate readings of **settleeable solids of 5% or less** in a variety of liquids to any depth
- Ideal for anywhere that accurate sample levels of settleable solids in noncaustic materials are needed
- Comes in three 5-ft. (1.53 m) sections with screw-type connectors
- Top section includes a nylon rope for raising and lowering the sampler
- Individual sections can be combined as required
- 1-ft. (.31 m) markers on the tubing help identify the amount of sludge in the tank
- Float valve for easy sample collection and release
- Not autoclavable
- **Do not use to sample ethanol or ethanol-blended motor fuel (see Nasco Fuel Sampler [B01477WA] pg. 33)**
- 1-year warranty
- Holds approximately 3 oz. per foot (89 ml per 0.31 m)
- 1" (2.54 cm) outside diameter clear plastic butyrate tubing
- Do not use in liquids over 165° F (74° C)
- Includes top section, extension section and bottom section

C09247WA 15-ft. (4.60 m) Sludge Judge Complete Unit.

The Sludge Judge® Replacement Parts

- C09252WA 5-ft. (1.53 m) Top Section with Rope.**
- C09251WA 5-ft. (1.53 m) Extension Section.**
- C09250WA 5-ft. (1.53 m) Bottom Section with Valve.**
- C14516WA Optional 2½-ft. (0.80 m) Top Section with Rope.**



THE SLUDGE JUDGE® ULTRA — SUPER STRONG

- For maximum strength and rigidity
- Constructed of extremely strong polycarbonate
- Treated with an ultraviolet stabilizer to help reduce deterioration from the sun's harmful rays
- Rigid materials minimize bending of the unit when full of water or other liquids
- Durable in cold temperatures; can withstand heat up to 280° F (138° C) with careful handling
- 1" (2.54 cm) outside diameter tubing is marked with blue tape to designate the 1-ft. measurements
- Float valve for easy sample collection and release

B01386WA Sludge Judge® Ultra Complete Unit.

B01387WA 5-ft. (1.53 m) Top Section with Rope.

B01388WA 5-ft. (1.53 m) Extension Section.

B01389WA 5-ft. (1.53 m) Bottom Section with Valve.



THE SLUDGE JUDGE® II – LARGE CAPACITY

- 1¼" (3.18 cm) outside diameter clear plastic butyrate tubing is very rigid when assembled
- Holds 6 oz. per foot (178 ml per .31 m)
- Float valve for easy sample collection and release
- Do not use in liquids over 165° F (74° C)

- B01355WA Sludge Judge® II Complete Unit.**
- B01358WA 5-ft. (1.53 m) Top Section with Rope.**
- B01357WA 5-ft. (1.53 m) Extension Section.**
- B01356WA 5-ft. (1.53 m) Bottom Section with Valve.**



A. CARRY BAG FOR SAMPLER
Holds four 5-ft. (1.52 m) sections of any Sludge Judge® product. Made of cotton canvas.

C09249WA

B. CLEANING BRUSHES
The cleaning brush used with a mild detergent and warm water will keep the unit clear so accurate sludge readings can be taken. It is made of galvanized steel wire and polyester bristles. Disassemble the unit and clean each section separately.

Cleaning Brush for Use for Sludge Judge® and Sludge Judge® Ultra. 6 ft. (1.83 m) L. 1" (2.54 cm) dia. bristle.

B01291WA

Cleaning Brush for The Sludge Judge® II. 6 ft. (1.83 m) L. 1½" (3.81 cm) dia. bristle.

B01361WA

NASCO COLLECTION TOOLS

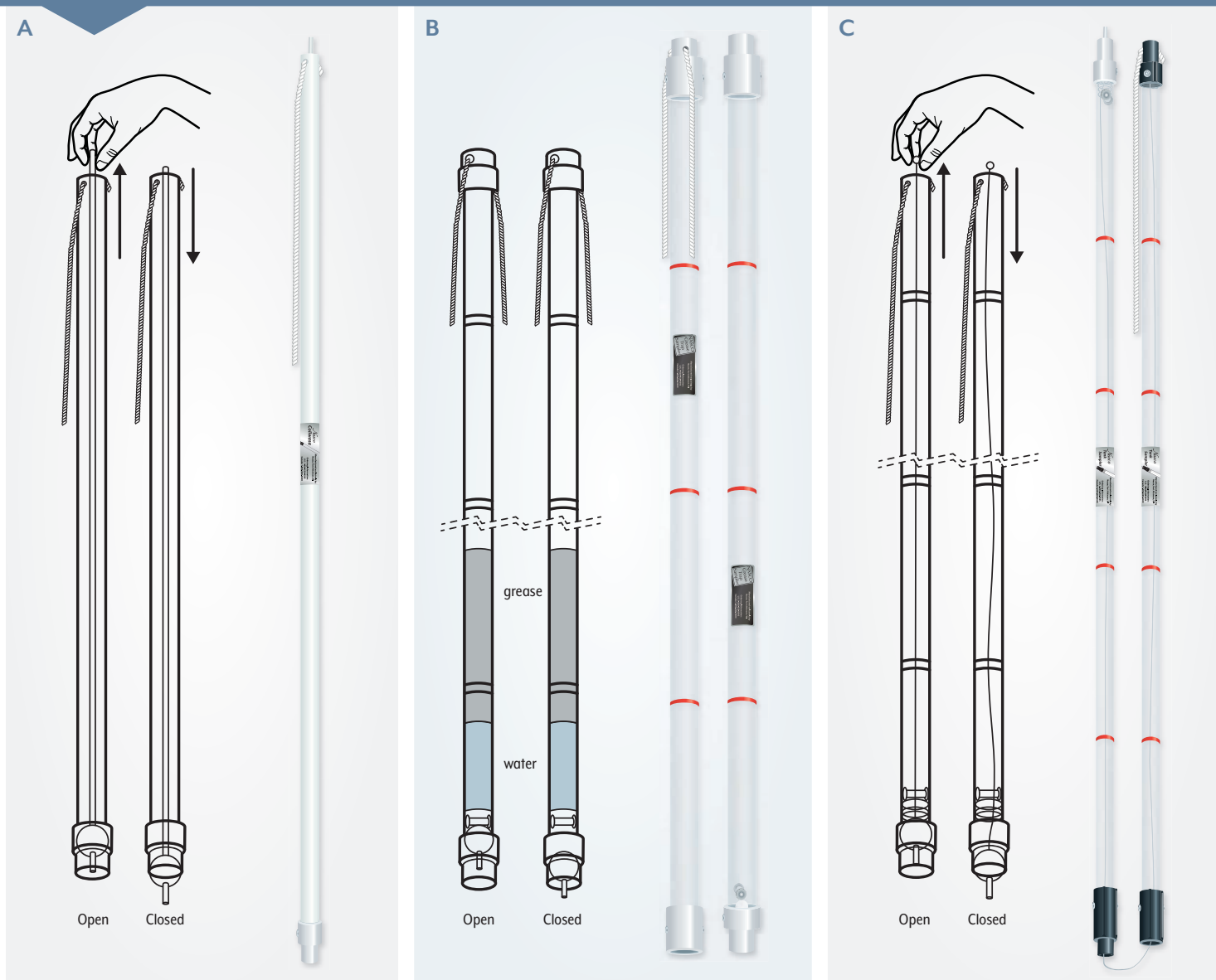

A. NASCO COLIWASA-COMPOSITE LIQUID WASTE SAMPLER

Nasco's COLIWASA permits representative sampling of multiphase wastes for a wide range of viscosity, corrosivity, volatility, and solids content. The unit can be used to sample most containerized liquid wastes, except those containing ketones, nitrobenzene, dimethylformamide, mesityl oxide, and tetrahydrofuran. Its simple design is easy to use, and allows the rapid collection of samples, minimizing the exposure of the sample collector to potential hazards from the wastes. Manufactured of high-density polyethylene (HDPE) and designed to EPA standards, the COLIWASA consists of a 5 ft. x $\frac{3}{4}$ " (1.53 m x 1.9 cm) ID tube and closing valve. Sampler holds approximately 3 oz. per foot (89 ml per .31 m). Not autoclavable.

B01098WA

B. NASCO GREASE TRAP SAMPLER

For measuring the grease level in a holding tank, the grease trap sampler is designed for sampling liquid grease and oils. Does not work with solid or semi-hardened materials. The inside diameter measures $1\frac{3}{8}$ " (3.5 cm) allowing small food particles to easily pass through the valve opening during sample collection. The clear tubing is easy to see through and the 1 ft. (0.31 m) red markers show the amount of grease accumulated in the tank. To use, slowly lower the sampler to the bottom of the tank; the valve opens and the liquid fills the tube. Lift the sampler up which closes the valve, holding the sample inside, showing the grease level. To empty, touch the plastic tip on a hard surface, and the liquid will flow out. The unit is made of two 4-ft. (1.22 m) sections that screw together. An extension is available to make the unit longer.

B01322WA Nasco Grease Trap Sampler Complete Unit.

B01479WA Top Section Only.

B01349WA 4-ft. (1.22 m) Extension Section.

B01480WA Bottom Section Only.

C. NASCO TANK SAMPLER — SPECIFIC DEPTH SAMPLING

Taking a sample at a specific depth is easy with Nasco's Tank Sampler. Available as a 10-ft. (3.05 m) unit, it is made up of two 5-ft. (1.53 m) sections that screw together. An extension section is available to make the unit longer. The sampler is made of a tough, $\frac{3}{4}$ " (1.9 cm) diameter, special plastic pipe. Sampler holds approximately 3 oz. per foot (89 ml per 30.50 cm). Made of butyrate. Cannot be used to sample ethanol or acetone.

B01096WA

Extension Section. 5-ft. (1.53 m) extension for the Tank Sampler. Comes with a length of stainless steel wire. To extend the unit, remove rope, untie the original wires, add the new wire between the two, and slide the wire through all the sections. NOTE: Because of flexibility of the plastic, longer units are subject to more bending when filled with liquid.

B01097WA



D. NASCO FUEL SAMPLER

For sampling ethanol and ethanol-blended motor fuels, the Nasco Fuel Sampler is efficient and easy to use. It is made up of three 5-ft. (1.53 m) sections of clear PVC that screw together to make a 15-ft. (4.60 m) length. As the sampler is lowered into the fuel tank, the float valve at the bottom opens, allowing the fuel up into the tube. When the bottom of the tank is reached, simply raise the sampler up to close the valve and hold the sample inside, showing a core section of the fuel. To empty, press the tip of the valve against the side of the tank and the contents will flow out. Clean the sampler with mild soapy water using the Nasco Cleaning Brush (B01291WA).

B01477WA

E. NASCO 6 FOOT FUEL SAMPLER WITH END CAP

Ideal for taking fuel samples from 38"–64" dia. tanks. The sampler is made of one 6-ft. (1.83 m) piece of clear PVC with an end cap. This sampler is the perfect size for tank sampling, and the end cap allows for either a core sample or bottom sample. Insert the sampler to the bottom of the tank, add the cap, and pull a core sample; or add the cap first, then insert and remove cap for a bottom sample.

B01555WA



F. CARRY BAG FOR SAMPLER

Holds four 5-ft. (1.52 m) sections of any Nasco sampler product. Made of cotton canvas.

C09249WA

G. CLEANING BRUSHES

The cleaning brush used with a mild detergent and warm water will keep the unit clear so accurate readings can be taken. It is made of galvanized steel wire and polyester bristles. Disassemble the unit and clean each section separately.

6 ft. (1.83 m) L. 1" (2.54 cm) dia. bristle.

B01291WA

6 ft. (1.83 m) L. 1½" (3.81 cm) dia. bristle.

B01361WA

SAMPLE REQUEST

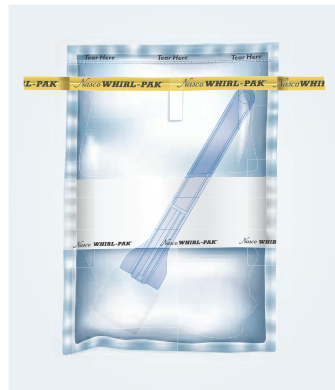
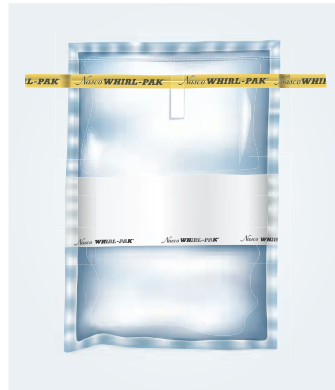

Complimentary sample bags

Our bags come in a variety of sizes and styles perfect for any sample collecting or processing task.

Ensure you have the right bag for the job.

Request complimentary samples today.

email: contact@whirl-pak.com

CONTACT



online
whirl-pak.com



phone
[+1.920.568.5616](tel:+19205685616)



email
contact@whirl-pak.com

Whirl-Pak® sterilized bags and sample collection tools are available through our wide network of global distributors.

For a distributor ideally suited for you, reach out to us at contact@whirl-pak.com.

STAY CONNECTED

sign up for our emails and get the latest sampling information delivered right to your inbox

follow us on Facebook at www.facebook.com/whirlpak

let's keep in touch





Nasco
SAMPLING^{brand}
901 Janesville Ave.
P.O. Box 901
Fort Atkinson, WI 53538-0901

PRSR STD
U.S. POSTAGE
PAID
NASCO

SPECIALTY MARKETS



CRAFT BREWING

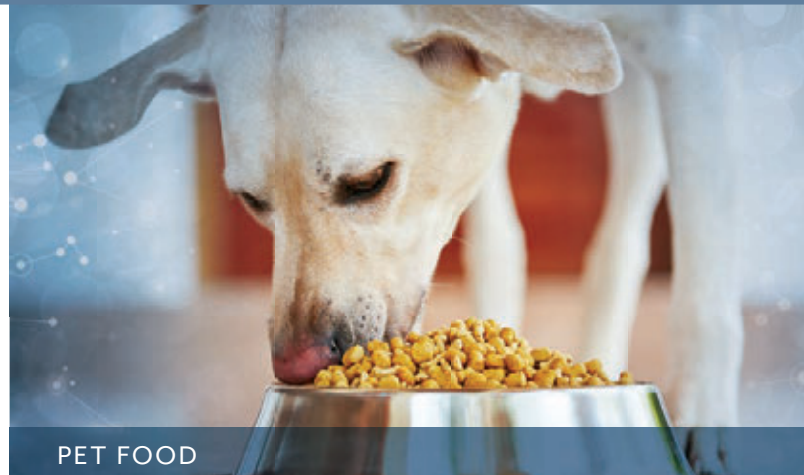

PET FOOD



CANNABIS RESEARCH



ORGANICS

The world of sample collection continues to grow in new and exciting ways. Whirl-Pak[®] bags offer the largest variety of sizes and styles to suit every market.

Nasco SAMPLING^{brand}